



LIGITEK

LIGITEK ELECTRONICS CO.,LTD.  
Property of Ligitek Only

---

ROUND TYPE LED LAMPS



Lead-Free Parts

**LH2040-PF**

**DATA SHEET**

DOC. NO : QW0905-LH2040-PF

REV. : A

DATE : 08 - Aug. - 2005





### Package Dimensions

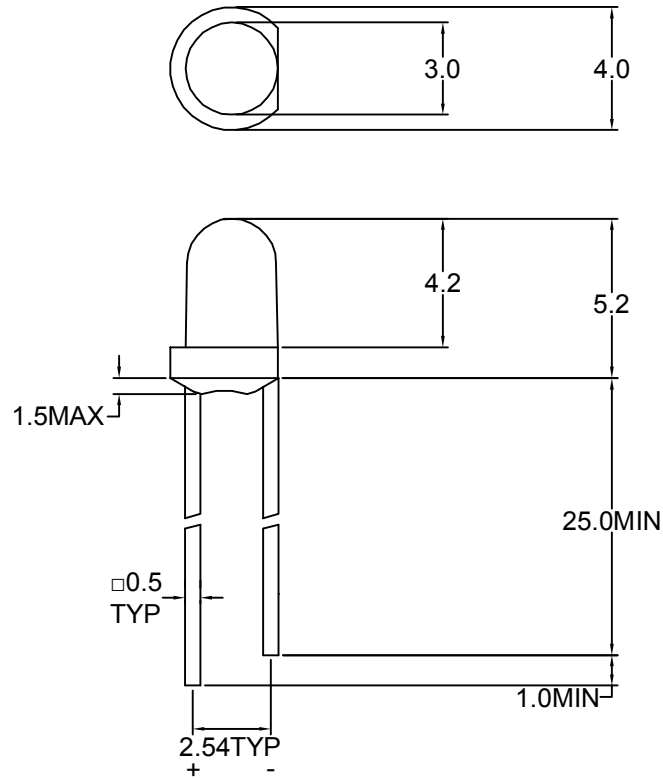

Note : 1.All dimension are in millimeter tolerance is  $\pm 0.25\text{mm}$  unless otherwise noted.  
2.Specifications are subject to change without notice.

### Directivity Radiation

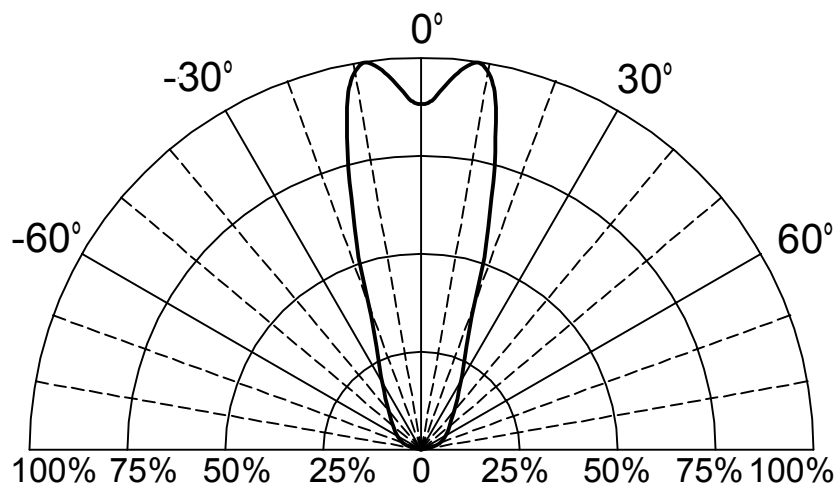



Absolute Maximum Ratings at Ta=25

Parameter	Symbol	Ratings	UNIT
		H	
Forward Current	IF	15	mA
Peak Forward Current Duty 1/10@10KHz	IFP	60	mA
Power Dissipation	PD	40	mW
Reverse Current @5V	Ir	10	μ A
Operating Temperature	Topr	-40 ~ +85	
Storage Temperature	Tstg	-40 ~ +100	
Soldering Temperature	Tsol	Max 260 for 5 sec Max (2mm from body)	

Typical Electrical & Optical Characteristics (Ta=25 )

PART NO	MATERIAL	COLOR		Peak wave length Pnm	Spectral halfwidth nm	Forward voltage @20mA(V)		Luminous intensity @10mA(mcd)		Viewing angle 2 1/2 (deg)
		Emitted	Lens			Min.	Max.	Min.	Typ.	
LH2040-PF	GaP	Red	Red Diffused	697	90	1.7	2.6	3.0	4.5	36

Note : 1.The forward voltage data did not including ±0.1V testing tolerance.  
2. The luminous intensity data did not including ±15% testing tolerance.



### Typical Electro-Optical Characteristics Curve

H CHIP

Fig.1 Forward current vs. Forward Voltage

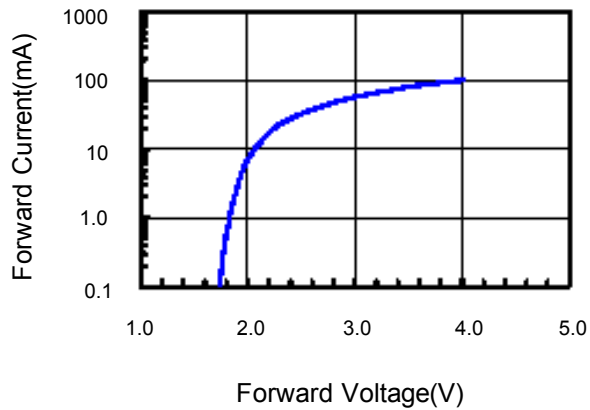

Fig.2 Relative Intensity vs. Forward Current

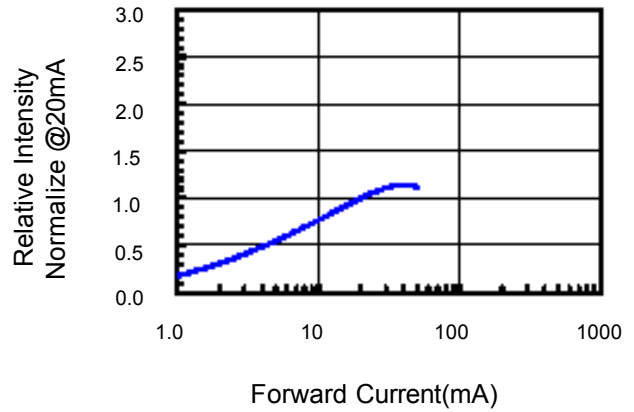

Fig.3 Forward Voltage vs. Temperature

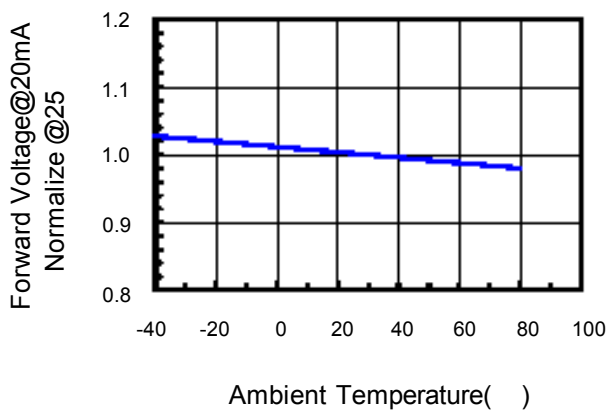

Fig.4 Relative Intensity vs. Temperature

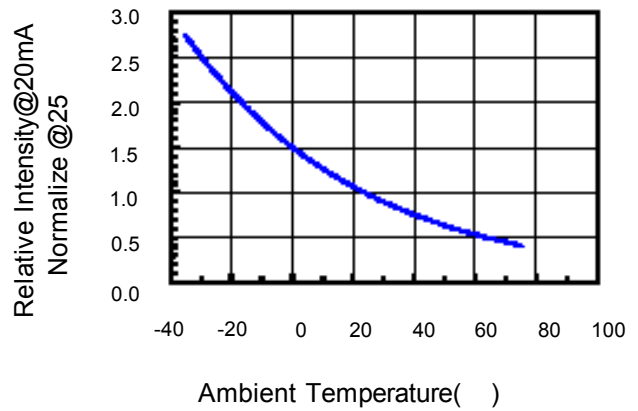
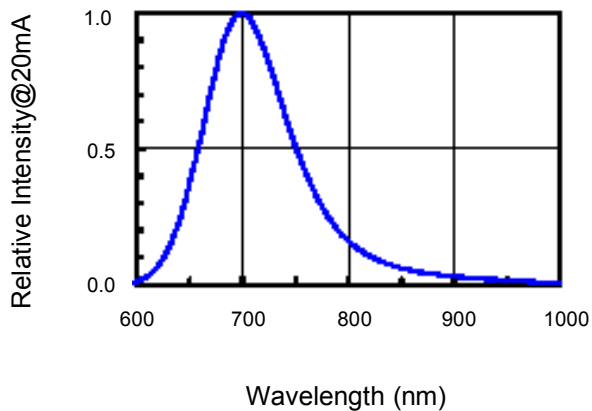

Fig.5 Relative Intensity vs. Wavelength





### Soldering Condition(Pb-Free)

#### 1.Iron:

- Soldering Iron:30W Max
- Temperature 350 °C Max
- Soldering Time:3 Seconds Max(One Time)
- Distance:2mm Min(From solder joint to case)

#### 2.Wave Soldering Profile

- Dip Soldering
- Preheat: 120°C Max
- Preheat time: 60seconds Max
- Ramp-up
- 3° C/sec(max)
- Ramp-Down:-5° C/sec(max)
- Solder Bath:260°C Max
- Dipping Time:3 seconds Max
- Distance:2mm Min(From solder joint to case)

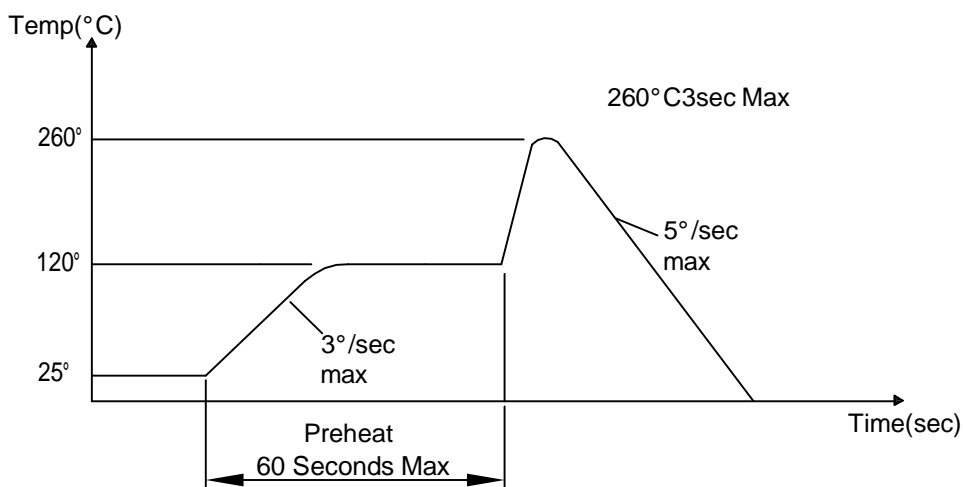

**Reliability Test:**

Test Item	Test Condition	Description	Reference Standard
Operating Life Test	1.Under Room Temperature 2.If=20mA 3.t=1000 hrs (-24hrs, +72hrs)	This test is conducted for the purpose of determining the resistance of a part in electrical and thermal stressed.	MIL-STD-750: 1026 MIL-STD-883: 1005 JIS C 7021: B-1
High Temperature Storage Test	1.Ta=105 ±5 2.t=1000 hrs (-24hrs, +72hrs)	The purpose of this is the resistance of the device which is laid under condition of high temperature for hours.	MIL-STD-883:1008 JIS C 7021: B-10
Low Temperature Storage Test	1.Ta=-40 ±5 2.t=1000 hrs (-24hrs, +72hrs)	The purpose of this is the resistance of the device which is laid under condition of low temperature for hours.	JIS C 7021: B-12
High Temperature High Humidity Test	1.Ta=65 ±5 2.RH=90 %~95 % 3.t=240hrs ±2hrs	The purpose of this test is the resistance of the device under tropical for hours.	MIL-STD-202:103B JIS C 7021: B-11
Thermal Shock Test	1.Ta=105 ±5 & -40 ±5 (10min) (10min) 2.total 10 cycles	The purpose of this is the resistance of the device to sudden extreme changes in high and low temperature.	MIL-STD-202: 107D MIL-STD-750: 1051 MIL-STD-883: 1011
Solder Resistance Test	1.T.Sol=260 ±5 2.Dwell time= 10 ±1sec.	This test intended to determine the thermal characteristic resistance of the device to sudden exposures at extreme changes in temperature when soldering the lead wire.	MIL-STD-202: 210A MIL-STD-750: 2031 JIS C 7021: A-1
Solderability Test	1.T.Sol=230 ±5 2.Dwell time=5 ±1sec	This test intended to see soldering well performed or not.	MIL-STD-202: 208D MIL-STD-750: 2026 MIL-STD-883: 2003 JIS C 7021: A-2



LIGITEK

## PACKING SPECIFICATION

1. 1000 PCS / BAG



2. 8 BAG / INNER BOX

SIZE : L X W X H 33.5cm X 19cm X 7.5cm

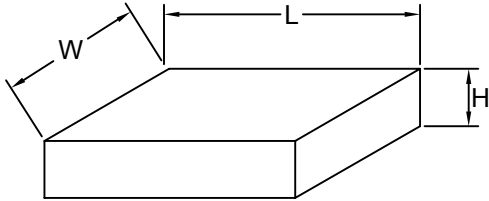

3. 12 INNER BOXES / CARTON

SIZE : L X W X H 58.5cm X 34cm X 34cm

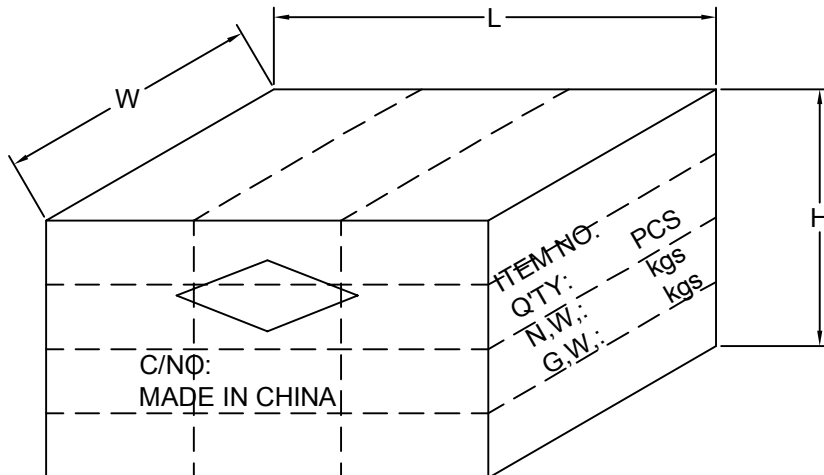

## Test Report

No. CANEC0904450201

Date: 27 Aug 2009

Page 1 of 7

GUANGZHOU PANYU LAPLING ELECTRONICS CO LTD  
NO.1 GUANGYI RD WESTEN INDUSTRIAL AREA NANSHA ETDZ PANYU GUANGZHOU  
CHINA

The following sample(s) was/were submitted and identified on behalf of the clients as :  
LAMP LED

SGS Job No. : 12132628 - GZ  
Date of Sample Received : 22 Jan 2009  
Testing Period : 22 Jan 2009 - 03 Feb 2009  
Test Requested : Selected test(s) as requested by client.  
Test Method : Please refer to next page(s).  
Test Results : Please refer to next page(s).

Signed for and on behalf of  
SGS-CSTC Ltd.



Sunny Huang  
Lab Sr. Supervisor

This document is issued by the Company under its General Conditions of Service printed overleaf or available on request and accessible at [http://www.sgs.com/terms\\_and\\_conditions.htm](http://www.sgs.com/terms_and_conditions.htm). Attention is drawn to the limitation of liability, indemnification and jurisdiction issues defined therein. Any holder of this document is advised that information contained hereon reflects the Company's findings at the time of its intervention only and within the limits of Client's instructions, if any. The Company's sole responsibility is to its Client and this document does not exonerate parties to a transaction from exercising all their rights and obligations under the transaction documents. Any unauthorized alteration, forgery or falsification of the content or appearance of this document is unlawful and offenders may be prosecuted to the fullest extent of the law. Unless otherwise stated the results shown in this test report refer only to the sample(s) tested. This document cannot be reproduced except in full, without prior approval of the Company.



## Test Report

No. CANEC0904450201

Date: 27 Aug 2009

Page 2 of 7

### Test Results:

ID for specimen 1 : CAN09-044502.001  
 Description for specimen 1 : Transparent body (mixed)

### Heavy metal(s)

Test Item(s)	Unit	Test Method (Reference)	Result	MDL
Cadmium (Cd)	mg/kg	IEC 62321:2008, ICP-OES	N.D.	2
Lead (Pb)	mg/kg	IEC 62321:2008, ICP-OES	N.D.	2
Mercury (Hg)	mg/kg	IEC 62321:2008, ICP-OES	N.D.	2
Hexavalent Chromium (CrVI) by alkaline extraction	mg/kg	IEC 62321:2008, UV-Vis	N.D.	2

### Note:

1. mg/kg = ppm
2. N.D. = Not Detected (< MDL)
3. MDL = Method Detection Limit

### Halogen

Test Item(s)	Unit	Test Method (Reference)	Result	MDL
Fluorine (F)	mg/kg	BS EN 14582:2007, IC	N.D.	50
Chlorine (Cl)	mg/kg	BS EN 14582:2007, IC	650	50
Bromine (Br)	mg/kg	BS EN 14582:2007, IC	N.D.	50
Iodine (I)	mg/kg	BS EN 14582:2007, IC	N.D.	50

### Note:

1. mg/kg = ppm
2. N.D. = Not Detected (< MDL)
3. MDL = Method Detection Limit

### Flame Retardants

Test Item(s)	Unit	Test Method (Reference)	Result	MDL
Sum of PBBs	mg/kg	-	N.D.	-
Monobromobiphenyl	mg/kg	IEC 62321:2008, GC-MS	N.D.	5
Dibromobiphenyl	mg/kg	IEC 62321:2008, GC-MS	N.D.	5
Tribromobiphenyl	mg/kg	IEC 62321:2008, GC-MS	N.D.	5
Tetrabromobiphenyl	mg/kg	IEC 62321:2008, GC-MS	N.D.	5
Pentabromobiphenyl	mg/kg	IEC 62321:2008, GC-MS	N.D.	5
Hexabromobiphenyl	mg/kg	IEC 62321:2008, GC-MS	N.D.	5

This document is issued by the Company under its General Conditions of Service printed overleaf or available on request and accessible at [http://www.sgs.com/terms\\_and\\_conditions.htm](http://www.sgs.com/terms_and_conditions.htm). Attention is drawn to the limitation of liability, indemnification and jurisdiction issues defined therein. Any holder of this document is advised that information contained hereon reflects the Company's findings at the time of its intervention only and within the limits of Client's instructions, if any. The Company's sole responsibility is to its Client and this document does not exonerate parties to a transaction from exercising all their rights and obligations under the transaction documents. Any unauthorized alteration, forgery or falsification of the content or appearance of this document is unlawful and offenders may be prosecuted to the fullest extent of the law. Unless otherwise stated the results shown in this test report refer only to the sample(s) tested. This document cannot be reproduced except in full, without prior approval of the Company.

# Test Report

No. CANEC0904450201

Date: 27 Aug 2009

Page 3 of 7

Test Item(s)	Unit	Test Method (Reference)	Result	MDL
Heptabromobiphenyl	mg/kg	IEC 62321:2008, GC-MS	N.D.	5
Octabromobiphenyl	mg/kg	IEC 62321:2008, GC-MS	N.D.	5
Nonabromobiphenyl	mg/kg	IEC 62321:2008, GC-MS	N.D.	5
Decabromobiphenyl	mg/kg	IEC 62321:2008, GC-MS	N.D.	5
Sum of PBDEs	mg/kg	-	N.D.	-
Monobromodiphenyl ether	mg/kg	IEC 62321:2008, GC-MS	N.D.	5
Dibromodiphenyl ether	mg/kg	IEC 62321:2008, GC-MS	N.D.	5
Tribromodiphenyl ether	mg/kg	IEC 62321:2008, GC-MS	N.D.	5
Tetrabromodiphenyl ether	mg/kg	IEC 62321:2008, GC-MS	N.D.	5
Pentabromodiphenyl ether	mg/kg	IEC 62321:2008, GC-MS	N.D.	5
Hexabromodiphenyl ether	mg/kg	IEC 62321:2008, GC-MS	N.D.	5
Heptabromodiphenyl ether	mg/kg	IEC 62321:2008, GC-MS	N.D.	5
Octabromodiphenyl ether	mg/kg	IEC 62321:2008, GC-MS	N.D.	5
Nonabromodiphenyl ether	mg/kg	IEC 62321:2008, GC-MS	N.D.	5
Decabromodiphenyl ether ##	mg/kg	IEC 62321:2008, GC-MS	N.D.	5

**Note:**

1. mg/kg = ppm
2. N.D. = Not Detected (< MDL)
3. MDL = Method Detection Limit
4. "-" = Not regulated
5. ## = The exemption of DecaBDE in polymeric application according 2005/717/EC was overruled by the European Court of Justice by its decision of 01.04.2008. Subsequently DecaBDE is included in the sum of PBDE after 01.07.2008

**PFOA & PFOS ( Perfluorooctanoic acid & Perfluorooctane sulfonates )**

Test Item(s)	Unit	Test Method (Reference)	Result	MDL
Perfluorooctanoic acid (PFOA)	mg/kg	EPA 3540C: 1996, LC-MS	N.D.	10
Perfluorooctane sulfonates (PFOS)	mg/kg	EPA 3540C: 1996, LC-MS	N.D.	10
PFOS Acid				
PFOS Metal Salt				
PFOS Amide				

**Note:**

1. mg/kg = ppm
2. N.D. = Not Detected (< MDL)
3. MDL = Method Detection Limit

This document is issued by the Company under its General Conditions of Service printed overleaf or available on request and accessible at [http://www.sgs.com/terms\\_and\\_conditions.htm](http://www.sgs.com/terms_and_conditions.htm). Attention is drawn to the limitation of liability, indemnification and jurisdiction issues defined therein. Any holder of this document is advised that information contained hereon reflects the Company's findings at the time of its intervention only and within the limits of Client's instructions, if any. The Company's sole responsibility is to its Client and this document does not exonerate parties to a transaction from exercising all their rights and obligations under the transaction documents. Any unauthorized alteration, forgery or falsification of the content or appearance of this document is unlawful and offenders may be prosecuted to the fullest extent of the law. Unless otherwise stated the results shown in this test report refer only to the sample(s) tested. This document cannot be reproduced except in full, without prior approval of the Company.

Reference Information: Directive 2006/122/EC

(1) May not be placed on the market or used as a substance or constituent of preparations in a concentration equal to or higher than 0.005 % by mass.

(2) May not be placed on the market in semi-finished products or articles, or parts thereof, if the concentration of PFOS is equal to or higher than 0.1 % by mass calculated with reference to the mass of structurally or microstructurally distinct parts that contain PFOS or, for textiles or other coated materials, if the amount of PFOS is equal to or higher than 1 $\mu$ g /m<sup>2</sup> of the coated material.

Remark1 : As requested by client, the test was conducted as whole / part sample, for the sample can't be disjointed.

Remark2: Results and photo(s) of this report refer to test report CANEC0900283301.

This document is issued by the Company under its General Conditions of Service printed overleaf or available on request and accessible at [http://www.sgs.com/terms\\_and\\_conditions.htm](http://www.sgs.com/terms_and_conditions.htm). Attention is drawn to the limitation of liability, indemnification and jurisdiction issues defined therein. Any holder of this document is advised that information contained hereon reflects the Company's findings at the time of its intervention only and within the limits of Client's instructions, if any. The Company's sole responsibility is to its Client and this document does not exonerate parties to a transaction from exercising all their rights and obligations under the transaction documents. Any unauthorized alteration, forgery or falsification of the content or appearance of this document is unlawful and offenders may be prosecuted to the fullest extent of the law. Unless otherwise stated the results shown in this test report refer only to the sample(s) tested. This document cannot be reproduced except in full, without prior approval of the Company.

### ATTACHMENTS

### Testing Flow Chart

- 1) Name of the person who made measurement: Luke Xu / Lily Lee
- 2) Name of the person in charge of measurement: Adams Yu / Leo Wang

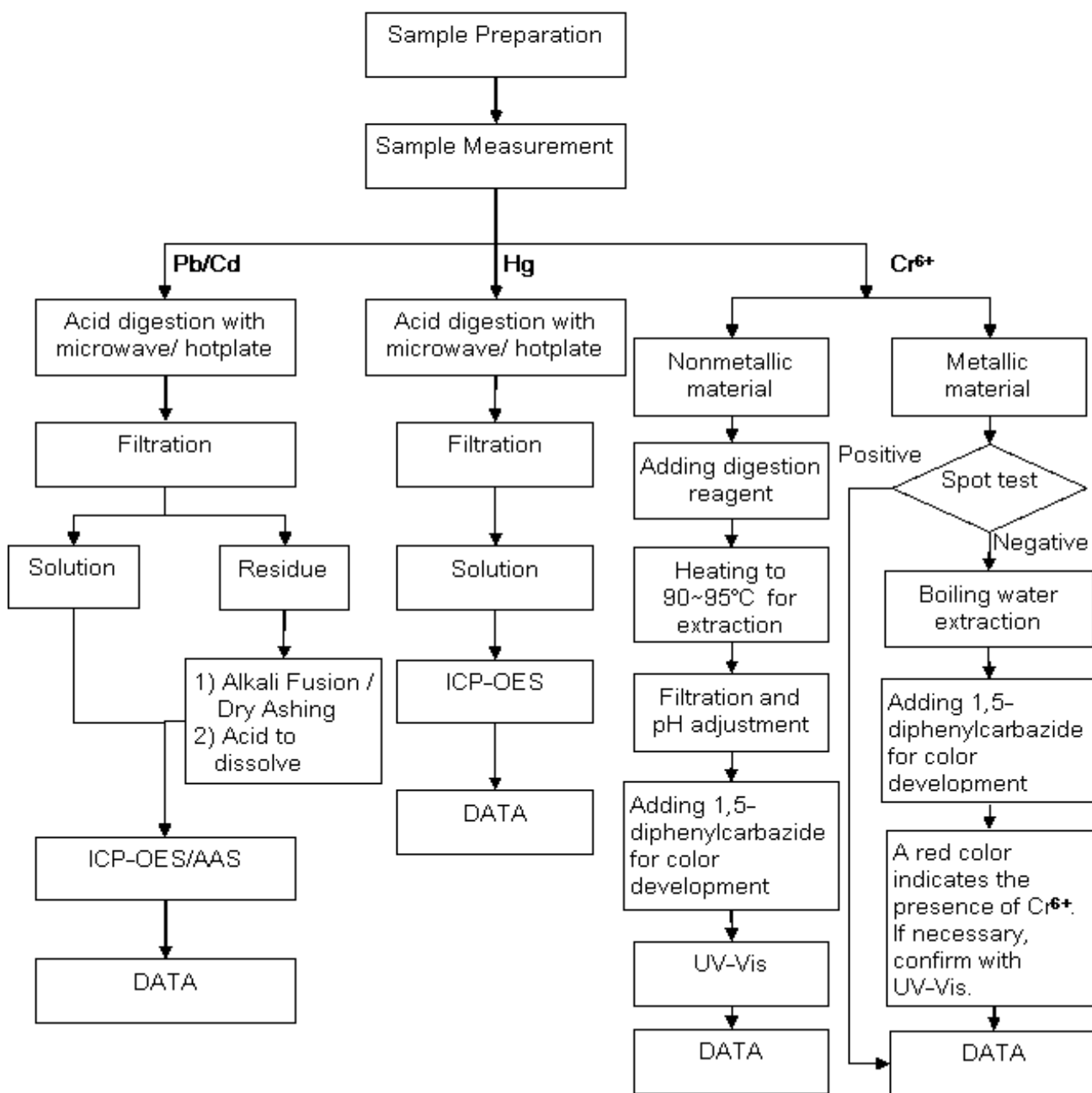

This document is issued by the Company under its General Conditions of Service printed overleaf or available on request and accessible at [http://www.sgs.com/terms\\_and\\_conditions.htm](http://www.sgs.com/terms_and_conditions.htm). Attention is drawn to the limitation of liability, indemnification and jurisdiction issues defined therein. Any holder of this document is advised that information contained hereon reflects the Company's findings at the time of its intervention only and within the limits of Client's instructions, if any. The Company's sole responsibility is to its Client and this document does not exonerate parties to a transaction from exercising all their rights and obligations under the transaction documents. Any unauthorized alteration, forgery or falsification of the content or appearance of this document is unlawful and offenders may be prosecuted to the fullest extent of the law. Unless otherwise stated the results shown in this test report refer only to the sample(s) tested. This document cannot be reproduced except in full, without prior approval of the Company.

### Testing Flow Chart

- 1) Name of the person who made measurement: Lina Tang
- 2) Name of the person in charge of measurement: Tina Zhao

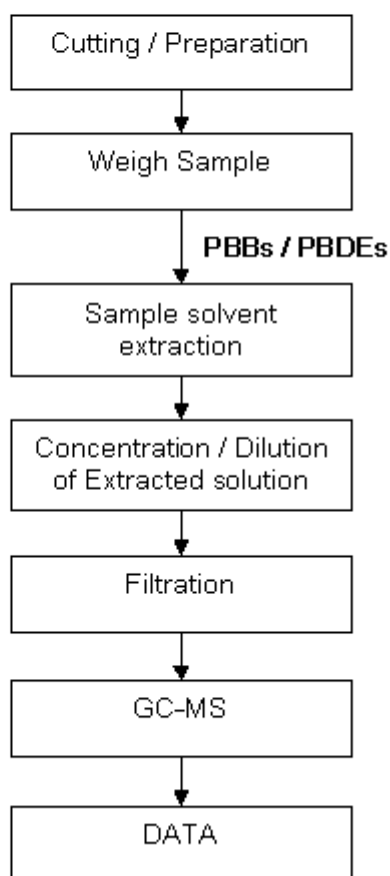

This document is issued by the Company under its General Conditions of Service printed overleaf or available on request and accessible at [http://www.sgs.com/terms\\_and\\_conditions.htm](http://www.sgs.com/terms_and_conditions.htm). Attention is drawn to the limitation of liability, indemnification and jurisdiction issues defined therein. Any holder of this document is advised that information contained hereon reflects the Company's findings at the time of its intervention only and within the limits of Client's instructions, if any. The Company's sole responsibility is to its Client and this document does not exonerate parties to a transaction from exercising all their rights and obligations under the transaction documents. Any unauthorized alteration, forgery or falsification of the content or appearance of this document is unlawful and offenders may be prosecuted to the fullest extent of the law. Unless otherwise stated the results shown in this test report refer only to the sample(s) tested. This document cannot be reproduced except in full, without prior approval of the Company.

Sample photo:

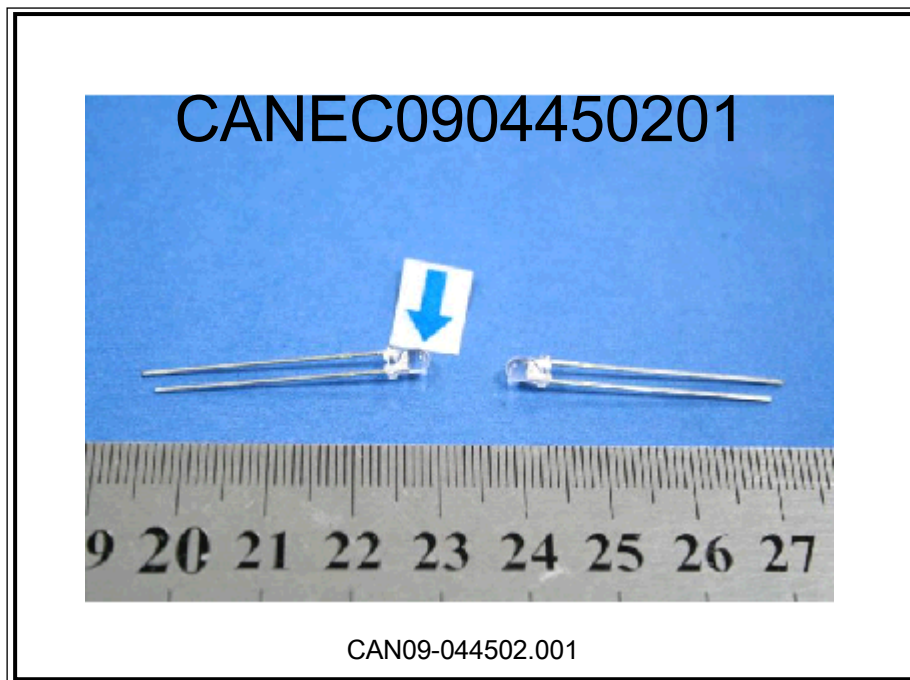

SGS authenticate the photo on original report only

\*\*\* End of Report \*\*\*

This document is issued by the Company under its General Conditions of Service printed overleaf or available on request and accessible at [http://www.sgs.com/terms\\_and\\_conditions.htm](http://www.sgs.com/terms_and_conditions.htm). Attention is drawn to the limitation of liability, indemnification and jurisdiction issues defined therein. Any holder of this document is advised that information contained hereon reflects the Company's findings at the time of its intervention only and within the limits of Client's instructions, if any. The Company's sole responsibility is to its Client and this document does not exonerate parties to a transaction from exercising all their rights and obligations under the transaction documents. Any unauthorized alteration, forgery or falsification of the content or appearance of this document is unlawful and offenders may be prosecuted to the fullest extent of the law. Unless otherwise stated the results shown in this test report refer only to the sample(s) tested. This document cannot be reproduced except in full, without prior approval of the Company.